

DESCRIPTION

The SQ Series of square plate axial flow fans is a high quality, robust product with 9 sizes ranging from 315 to 1250mm diameter. They are suitable for a wide range of commercial and industrial applications.

Typical Applications

Capable of exhausting or supplying air in diverse environments ie. ambient air, hot air, as well as toxic, noxious, corrosive and explosive gases. See Special Note.

Features

- Heavy duty, hot-dipped galvanised steel construction.
- Wide range of speeds and capacities available.
- Speed-controllable using variable speed drives.
- Conical inlet improves air flow and noise performance.
- Case available in other materials such as stainless steel.
- Can be supplied with special coatings.
- Tech-Lock® bushes are standard to facilitate the easy removal and fitting of impellers for cleaning and maintenance.
- Impeller blades are injection moulded GRP. Aluminium, nylon and anti-static blades are also available for explosion risk applications.
- For Smoke-Spill applications - The SQ Series has been tested to meet the air performance and high temperature test requirements of Standards AS/NZS1668.1:2015 and AS/NZS4429:1999.
- Can be mounted in any position.
- Extensive range of matching ancillary equipment available.

Construction

The square plate is of hot-dipped galvanised steel construction. Impellers are GRP. Aluminium, nylon and anti-static blades are also available.

Motors

Type - squirrel cage induction motor.

Electricity Supply - 230V, single or 415V three-phase, 50Hz.

Bearings - sealed for life, ball.

Speed-controllable using variable speed drives.

Maximum ambient when being speed-controlled is 40°C.

Motors for a wide range of non-standard applications can be fitted.

See pages O-3/4 for details of these motors.

Internal Thermal Protection

Can be provided as an optional extra

Testing

Air flow testing to BS848:Part 1, 1980 or ISO5801:1997

Noise tests to BS848:Part 2, 1985

Wiring Diagram

See section N

Weights

See pages C-28/29 for details.

ANCILLARY EQUIPMENT

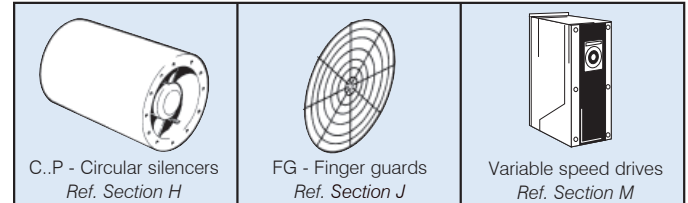

SPECIAL NOTE

Quick selection envelope curves are shown on pages A-22/23. For more accurate selections refer to the Fans by Fantech Product Selections Program.

Selection should be made using Type A installation (Free inlet, Free outlet). Refer to page C-2 for further information.

SUGGESTED SPECIFICATION

The square plate axial flow fans shall be of the SQ Series as designed and manufactured by Fantech Pty Ltd and be of the model numbers shown on the schedule/drawings.

Square plates shall be of hot-dipped galvanised steel. Impellers shall be of GRP, nylon, aluminium or anti-static as required for the application.

All performances shall be based upon tests to BS848:Part 1, 1980 or ISO5801: 1997 for air flow and BS848:Part 2, 1985 for noise.

HOW TO ORDER

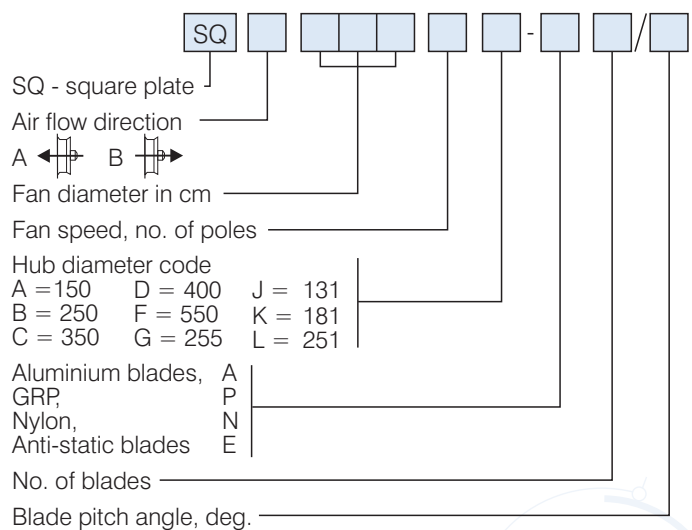

Scan the QR Code to view more information online.



SQ SERIES

A

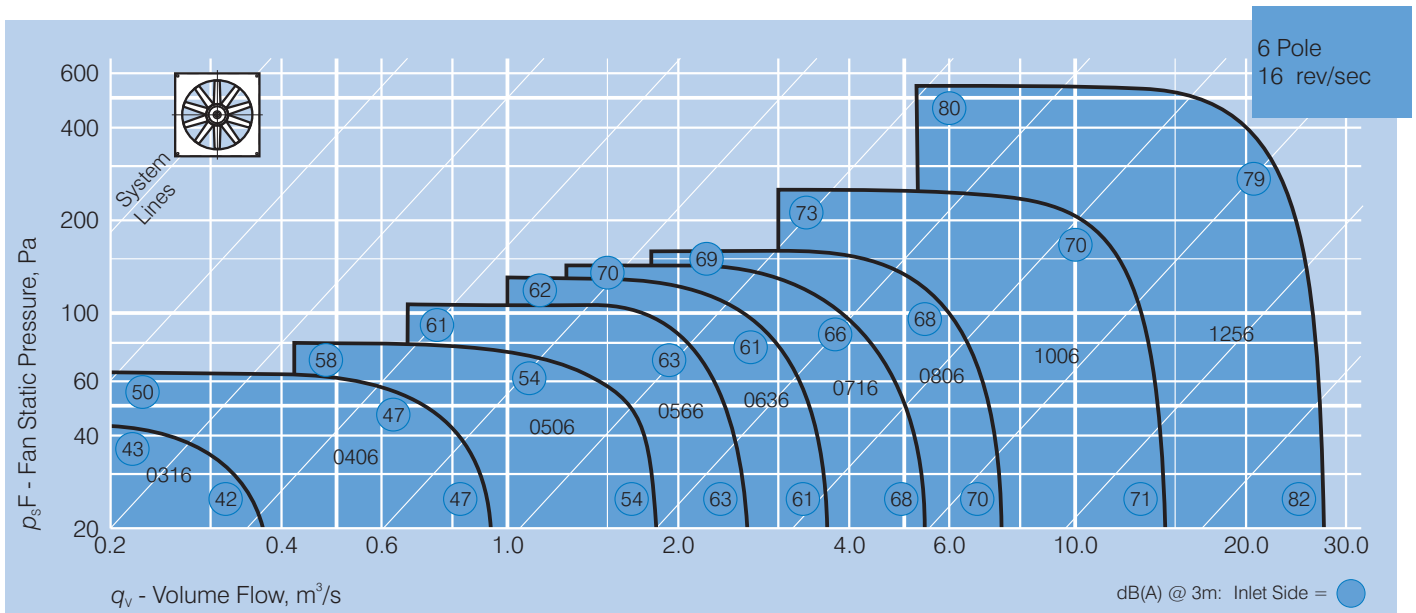
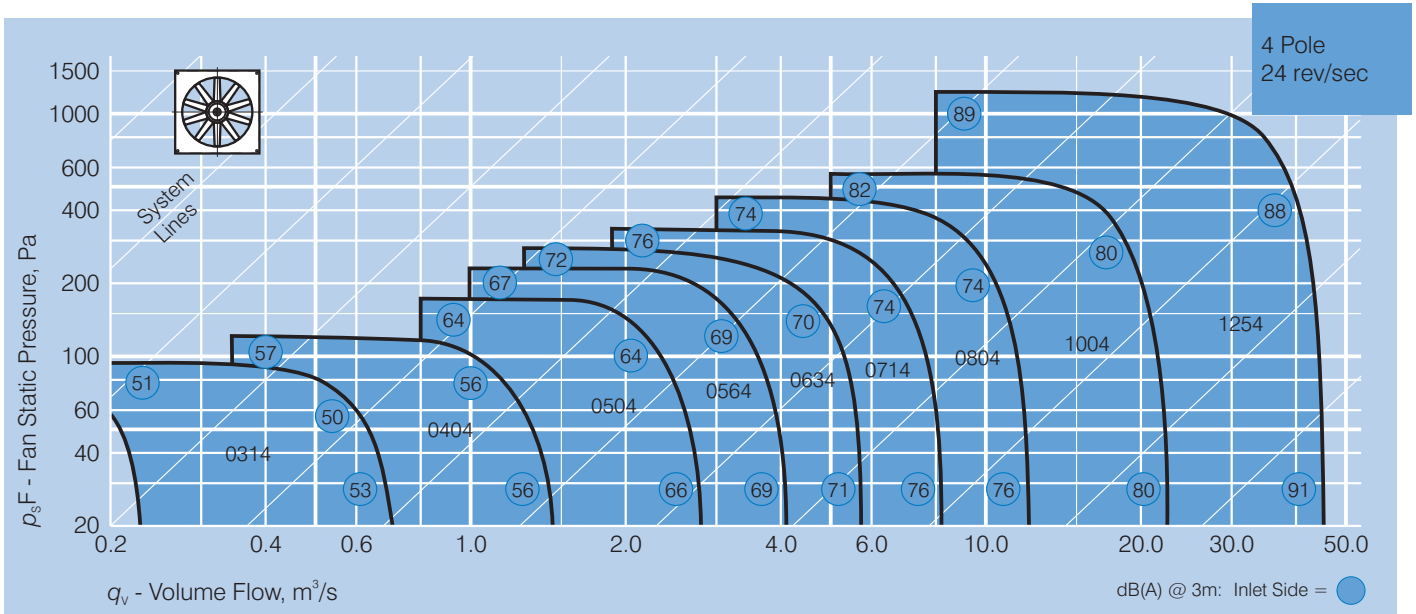
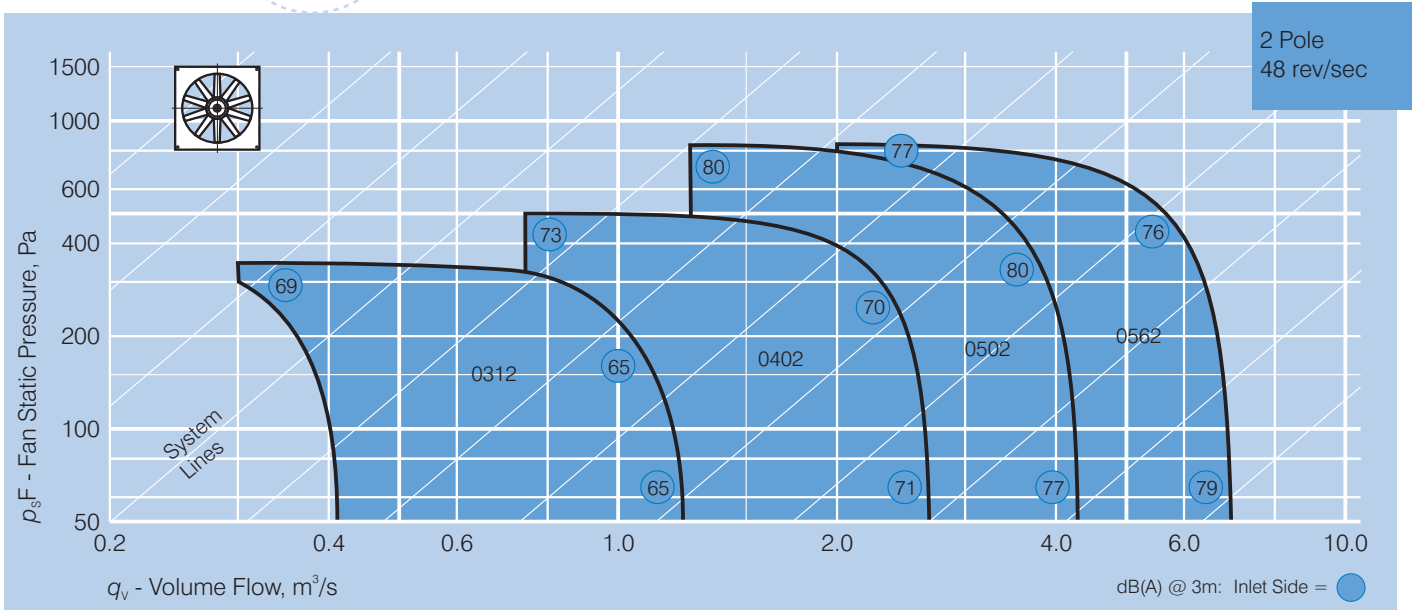

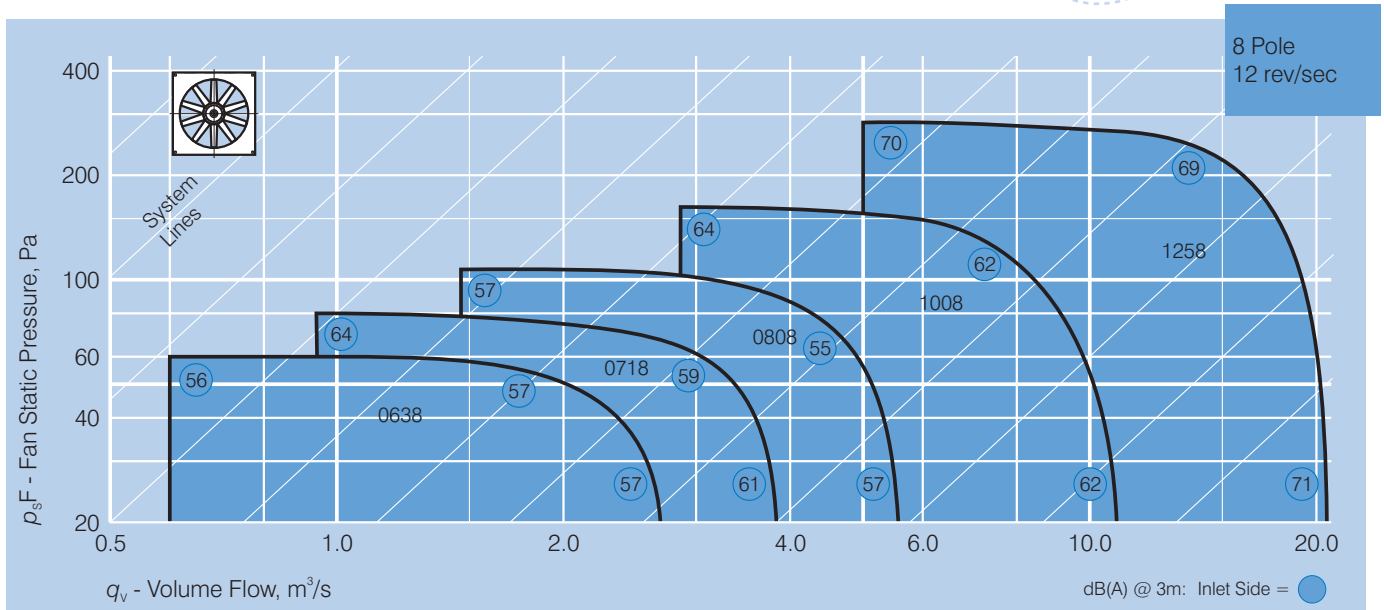

DIMENSIONS

Model Number SQA/B..	Dimensions, mm					
	A□	B□	C∅	D∅	E∅	F1*
0312/4/6	430	380	315	382	9	420
0402/4/6	540	490	400	467	9	420
0502/4/6	655	615	500	587	11	460
0562/4/6	725	675	560	647	11	460
0634/6/8	805	750	630	717	11	460
0714/6/8	850	810	710	797	14	490
0804/6/8	970	910	800	887	14	490
1004/6/8	1170	1110	1000	1088	14	See Motor frame table
1254/6/8	1420	1360	1250	1338	14	See Motor frame table

Unit weights can be determined from pages C-28/29

* F1 is applicable to fans with motors up to D112M frame. See Motor frame table
F2 for sizes D132S and above.

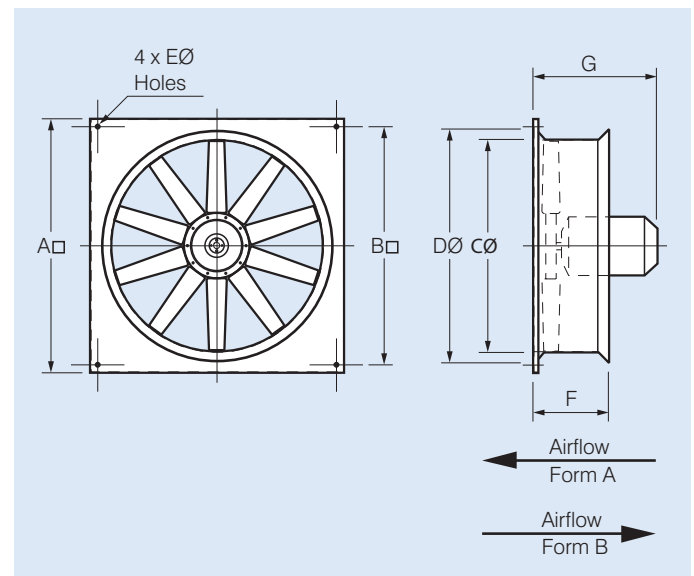

Motor frame table

Frame size	F2†	G**
D80	490	475
D90S	490	504
D90L	490	529
D100L	530	607
D112M	530	650
D132S	600	683
D132M	600	723
D160M	735	793
D160L	735	838
D180M	770	859
D180L	770	899

† F2 is applicable for ∅310 to ∅800 fans with motors D132S frame and above and to all motor frame sizes for ∅1000 and ∅1200 fans.

**Dimension G can vary with the make of the motor