

MULTIFLOW SERIES

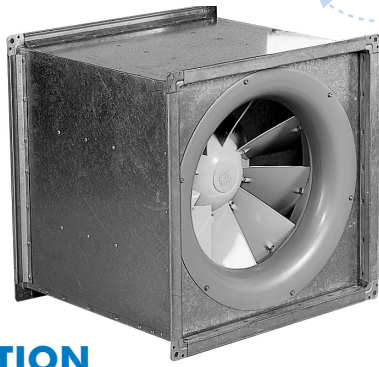

DESCRIPTION

The Multiflow Series of In-Line Mixed-Flow Fans is designed for a wide range of duct mounted applications. They are most suitable in applications where higher air flows are required at medium pressures. A particular feature of this product is its low noise levels in comparison to axial and centrifugal selections. They are available in various speed options and in 9 sizes, extending from 250 to 800mm diameter.

Typical Applications

Commercial and industrial supply or exhaust air applications such as shopping centres, office buildings, exhibition centres, hotels, health centres, schools and universities.

Features

- Robust, yet lightweight galvanised steel construction.
- Easy to fit 35mm TDF profile flange connections.
- Patented, adjustable pitch, mixed-flow impellers.
- Large choice of speeds available.
- To improve energy efficiency motors can be speed-controlled.
- Motors complying with Ex d, Ex e, Ex nA and Ex tD. Standards can be fitted.
- Can be mounted in any position.
- A range of matching ancillaries is also available.

Construction

Galvanised steel housings with 35mm TDF profile flange connections. Patented, adjustable pitch, mixed-flow impellers made from aluminium.

Sizes 250 to 450 are available in a choice of 2 impeller pitch angle settings.

Sizes 500-800 are available in a choice of 4 or 5 impeller pitch angle settings.

Motors

Type - standard TE motors.

Electricity supply - single or three-phase to suit a wide range of voltages and frequencies.

Bearings - sealed-for-life, ball.

Motors can be single or multi-speed.

Three-phase motors for size 500 to 800, can be speed-controlled using variable speed drives.

See pages O-3/4 for details on standard TE motors.

If motors complying with Ex d, Ex e, Ex nA and Ex tD. Standards are required, selections can be made from these pages.

Internal thermal Protection

Manual-reset protection is supplied as standard up to size 450. For fans 500 and above, thermal protection is an optional extra.

Testing



Air flow tests to BS848:Part 1, 1980

Noise tests to BS848:Part 2, 1985

Wiring Diagram

See pages N-6/7, diagrams DD1, 2, 3, 5, 6, 9

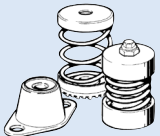
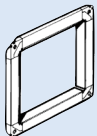
ANCILLARY EQUIPMENT

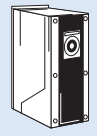
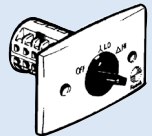
 <p>Vibration Isolators Ref. Section I</p>	 <p>POW - Matching Flanges Ref. Section J</p>	 <p>FT - Mounting Foot Ref. Section J</p>
 <p>VA - Speed controllers Ref. Section M</p>	 <p>Variable speed drives Ref. Section M</p>	 <p>SD - Star/Delta switch Ref. Section M</p>

SUGGESTED SPECIFICATION

The Multiflow Mixed-Flow In-Line Fans shall be as designed and manufactured by Fantech Pty Ltd and be of the model numbers shown on the schedule/drawings.

The mixed-flow impeller shall be of patented, adjustable pitch design, manufactured from aluminium and driven by standard TE motors.

Housings shall be of galvanised steel with 35mm TDF profile flange connections.

All models shall be fully tested to BS848:Part 1, 1980 for air flow and BS848:Part 2, 1985 for noise.

HOW TO ORDER

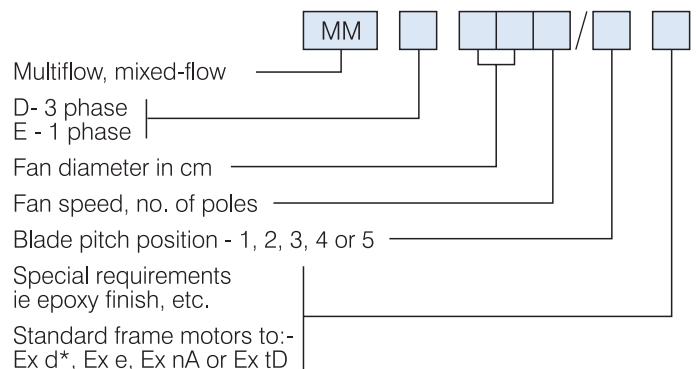

* Please check with your local Fantech office if Ex d motors are available for a specific selection.

NOISE DATA

Model	MMD..	MME..		In-Duct Sound Power Levels, dB*							
				63	125	250	500	1k	2k	4k	8k
254	Inlet	Outlet		25	26	22	18	12	11	11	0
				22	21	20	17	15	14	7	-2
314	Inlet	Outlet		24	24	21	17	12	13	10	0
				22	21	20	17	15	14	7	-1
354	Inlet	Outlet		24	24	21	17	12	15	11	1
				23	21	19	17	14	14	8	-1
356	Inlet	Outlet		22	24	19	16	15	13	10	0
				16	19	14	18	18	10	3	-4
404	Inlet	Outlet		20	20	18	16	12	15	12	4
				17	18	17	18	16	14	9	3
406	Inlet	Outlet		22	24	18	18	16	13	10	0
				15	17	13	18	18	8	4	-5
454	Inlet	Outlet		20	20	18	15	12	15	12	4
				17	15	17	16	16	13	10	1
456	Inlet	Outlet		22	23	20	16	15	14	9	1
				18	20	17	18	17	11	6	-2
504											
506											
564											
566											
636											
638											
806											
808											

See pages B-44/45 for noise data on these sizes

All values are positive unless shown otherwise.

* Sound Power Levels shown are the highest for each fan model and for the Inlet Side of the unit.

DIMENSIONS

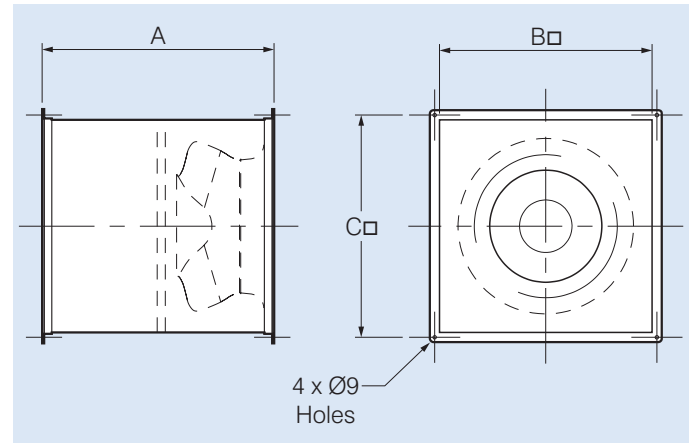

Model	Dimensions, mm			Approx. weight
Number	A	B	C	kg
25.	420	350	383	16
31.	500	400	433	23
35.	550	450	483	26
40.	600	500	533	34
45.	600	550	583	37
50.	700	650	683	81
56.	800	725	758	106
63.	850	800	833	116
80.	900	1000	1033	182

PERFORMANCE CURVES

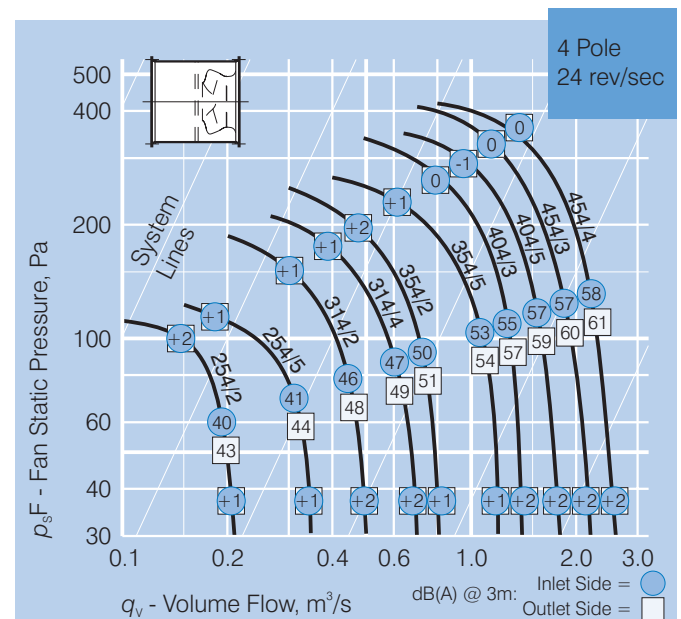
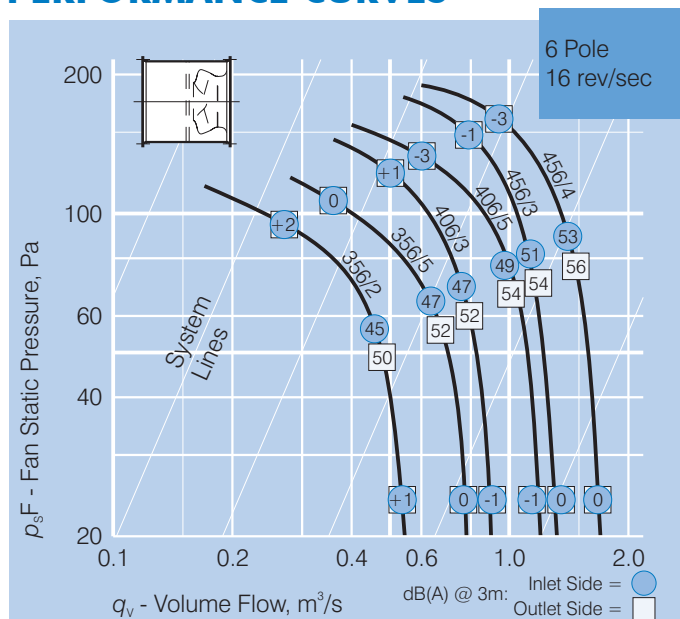

The figures in the box are correction factors to apply to the dB(A) figure for the Inlet or Outlet Side.

MULTIFLOW SERIES

PERFORMANCE CURVES

The noise values shown in the graphs are mean dB(A) levels at 3 metres in free field conditions based on spherical radiation.

* In-duct Sound Power Levels across the spectrum can be determined by adding the In-Duct Spectrum Corrections to the appropriate dB(A) level determined from the graph. The figures in the box  are correction factors to apply to the dB(A) figure for the Inlet or Outlet Side.

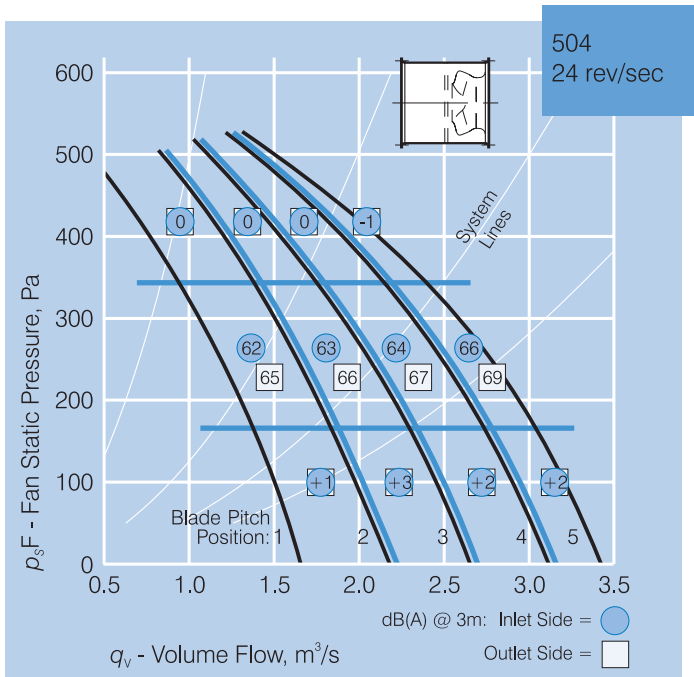
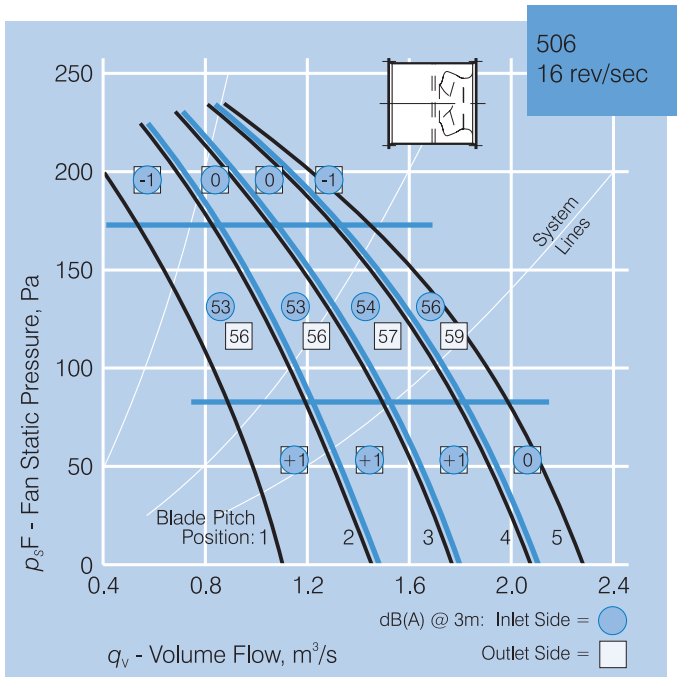

Frequency, Hz	In-Duct Spectrum Corrections, dB*							
	63	125	250	500	1k	2k	4k	8k
Inlet Side	21	23	21	16	13	14	9	1
Outlet Side	19	20	19	10	16	12	8	0

Frequency, Hz	In-Duct Spectrum Corrections, dB*							
	63	125	250	500	1k	2k	4k	8k
Inlet Side	19	19	18	16	13	15	10	4
Outlet Side	15	10	16	16	17	13	9	2

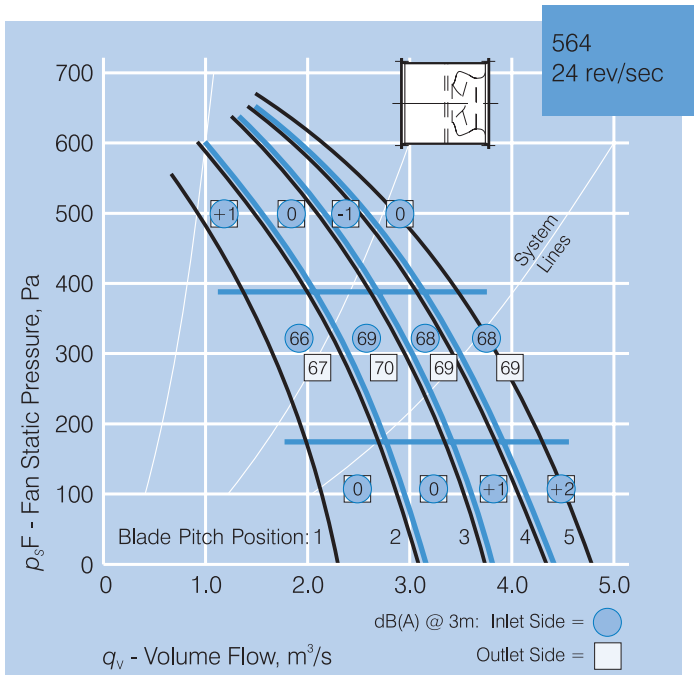
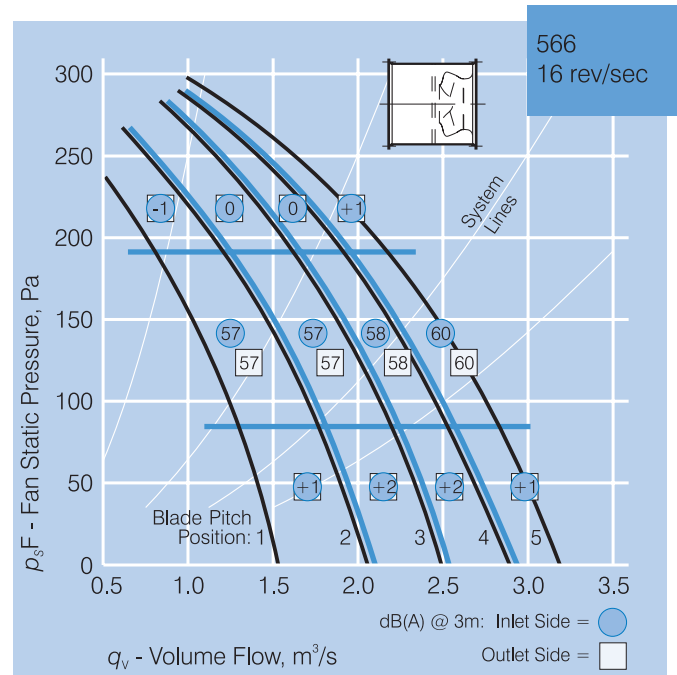

Frequency, Hz	In-Duct Spectrum Corrections, dB*							
	63	125	250	500	1k	2k	4k	8k
Inlet Side	21	22	22	17	14	13	8	6
Outlet Side	21	20	20	19	16	12	8	0

Frequency, Hz	In-Duct Spectrum Corrections, dB*							
	63	125	250	500	1k	2k	4k	8k
Inlet Side	18	14	18	13	15	15	11	3
Outlet Side	17	13	17	16	17	13	10	2

PERFORMANCE CURVES

The noise values shown in the graphs are mean dB(A) levels at 3 metres in free field conditions based on spherical radiation.

* In-duct Sound Power Levels across the spectrum can be determined by adding the In-Duct Spectrum Corrections to the appropriate dB(A) level determined from the graph. The figures in the box  are correction factors to apply to the dB(A) figure for the Inlet or Outlet Side.

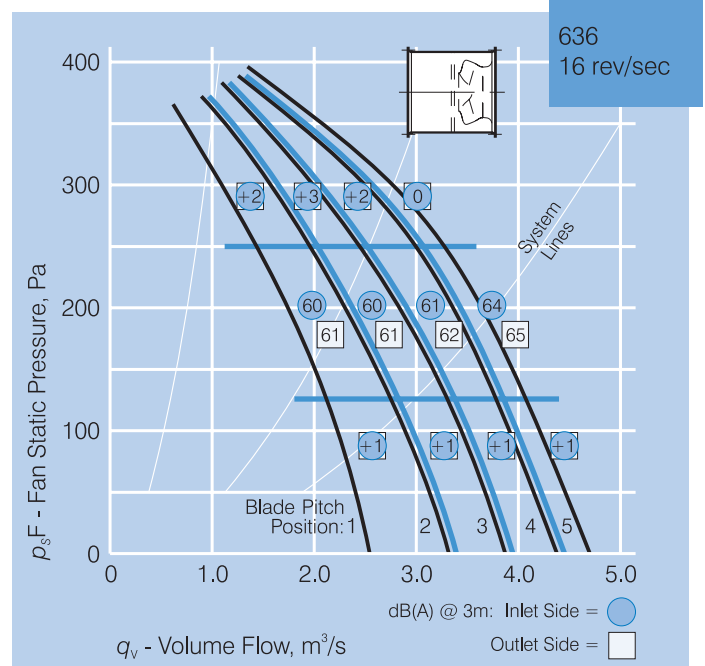
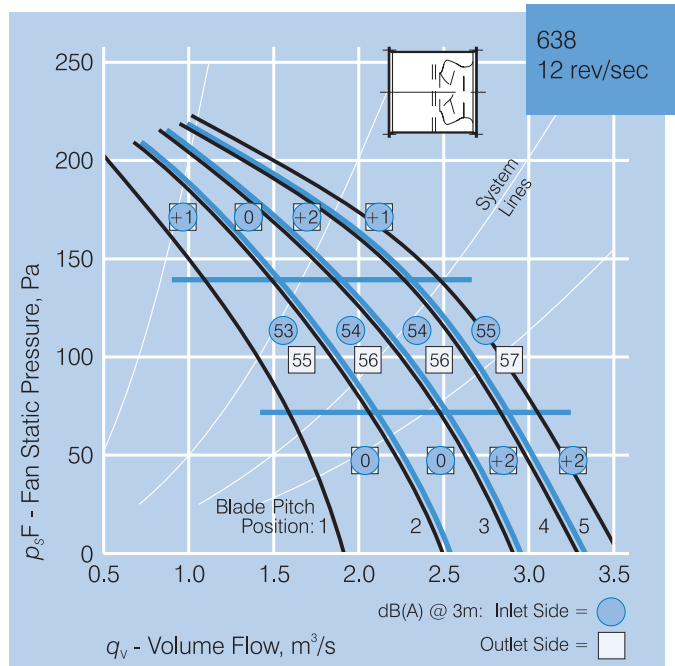

Frequency, Hz	In-Duct Spectrum Corrections, dB*							
	63	125	250	500	1k	2k	4k	8k
Inlet Side	22	22	23	17	15	12	7	-1
Outlet Side	21	19	18	19	15	11	6	-3

Frequency, Hz	In-Duct Spectrum Corrections, dB*							
	63	125	250	500	1k	2k	4k	8k
Inlet Side	21	20	18	16	15	14	9	1
Outlet Side	19	17	15	18	16	13	8	-1

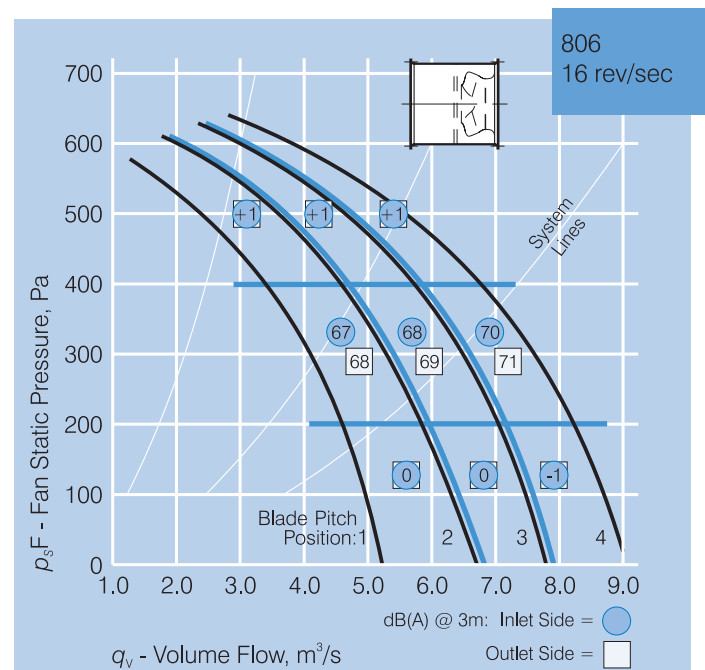
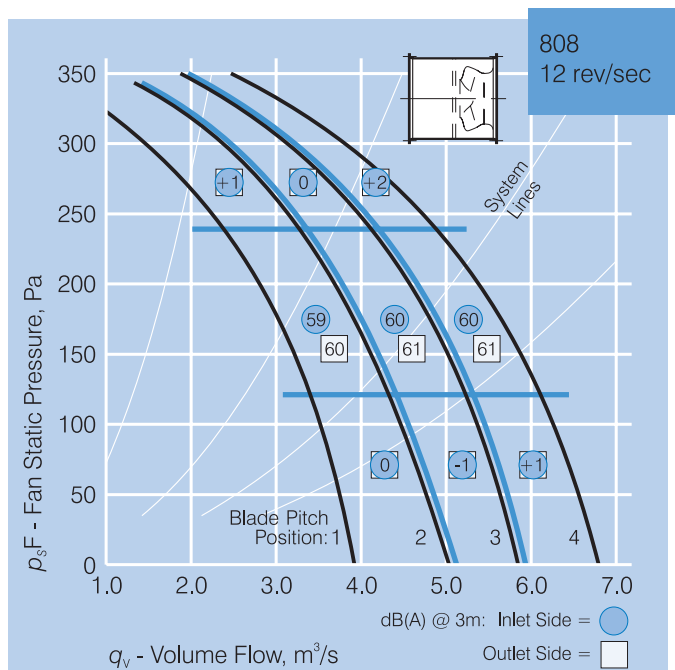

Frequency, Hz	In-Duct Spectrum Corrections, dB*							
	63	125	250	500	1k	2k	4k	8k
Inlet Side	23	21	21	18	16	12	7	-1
Outlet Side	20	19	18	20	16	11	5	-4

Frequency, Hz	In-Duct Spectrum Corrections, dB*							
	63	125	250	500	1k	2k	4k	8k
Inlet Side	22	21	19	16	15	13	9	-1
Outlet Side	20	19	17	19	16	13	8	-1

MULTIFLOW SERIES

TECHNICAL DATA

Model MMD.. MME..	Fan Speed rev/sec	Peak kW	MME..1 ph.		MMD..3 ph.	
			kW	Amps	kW	Amps
254 / 5	24	0.06	0.09	0.09	0.12	0.50
/ 2		0.04	0.09	0.09	0.12	0.50
314 / 4	24	0.18	0.25	1.80	0.37	1.40
/ 2		0.13	0.25	1.80	0.37	1.40
354 / 5	24	0.36	0.55	3.60	0.37	1.40
/ 2		0.23	0.25	1.80	0.37	1.40
356 / 5	16	0.11	0.12	1.05	0.18	0.68
/ 2		0.07	0.12	1.05	0.18	0.68
404 / 5	24	0.70	0.55	3.60	0.55	1.75
/ 3		0.45	0.55	3.60	0.55	1.75
406 / 5	16	0.21	0.25	2.20	0.25	0.94
/ 3		0.14	0.18	1.55	0.18	0.94
454 / 4	24	1.00	-	-	1.5	4.30
/ 3		0.75	-	-	0.75	2.00
456 / 4	16	0.36	0.25	2.20	0.25	0.94
/ 3		0.23	0.25	2.20	0.25	0.94
504 / 5	24	1.91	-	-	2.2	4.50
/ 4		1.64	-	-	2.2	4.50
/ 3		1.40	1.5	9.40	1.5	3.30
/ 2		1.23	1.5	9.40	1.5	3.30
/ 1		1.07	1.5	9.40	1.5	3.30
506 / 5	16	0.56	0.55	-	0.55	1.70
/ 4		0.49	0.55	-	0.55	1.70
/ 3		0.42	0.55	-	0.55	1.70
/ 2		0.37	0.55	-	0.55	1.70
/ 1		0.32	0.55	-	0.55	1.70

Check fan nameplate for exact amperages of all motors.

Model MMD.. MME..	Fan Speed rev/sec	Peak kW	MME..1 ph.		MMD..3 ph.	
			kW	Amps	kW	Amps
564 / 5	24	2.98	-	-	4.0	8.00
/ 4		2.58	-	-	3.0	6.30
/ 3		2.15	-	-	2.2	4.50
/ 2		1.85	-	-	2.2	4.50
/ 1		1.62	-	-	2.2	4.50
566 / 5	16	0.90	-	-	1.1	2.90
/ 4		0.77	-	-	1.1	2.90
/ 3		0.63	-	-	0.75	2.10
/ 2		0.56	-	-	0.75	2.10
/ 1		0.47	-	-	0.75	2.10
636 / 5	16	1.80	-	-	2.2	5.14
/ 4		1.60	-	-	2.2	5.14
/ 3		1.22	-	-	1.5	3.60
/ 2		1.18	-	-	1.5	3.60
/ 1		1.08	-	-	1.5	3.60
638 / 5	12	0.74	-	-	0.75	2.21
/ 4		0.68	-	-	0.75	2.21
/ 3		0.57	-	-	0.75	2.21
/ 2		0.49	-	-	0.55	1.51
/ 1		0.45	-	-	0.55	1.51
806 / 4	16	5.30	-	-	5.5	11.50
/ 3		4.30	-	-	5.5	11.50
/ 2		3.60	-	-	4.0	8.50
/ 1		2.70	-	-	4.0	8.50
808 / 4	12	2.20	-	-	2.2	4.90
/ 3		1.85	-	-	2.2	4.90
/ 2		1.60	-	-	2.2	4.90
/ 1		1.35	-	-	2.2	4.90



Scan the QR Code
to view more
information online.

