

B



## DESCRIPTION

The ECOtronic EC Series of Powerline centrifugal fan incorporates an IE6\* rated Electronically Commutated (EC) shaft motor delivering ultra energy efficient operation with the benefit of in-built variable speed control. Via a range of common control signals, the ECOtronic can be easily designed into a Demand Control Ventilation system without the need for a VSD and overload protection.

The ECOtronic EC fans are a simple “plug and play” system which means installers do not need to have specialised control programming knowledge. The series is available in 6 sizes ranging from 315 to 560mm diameter.

## Typical Applications

The ECOtronic Powerline is most efficient in applications where conditions vary during the course of the day such as shopping centres, office buildings, exhibition centres, hotels, health centres, schools and universities.

## Features



- EC motor features reverse polarity protection, locked rotor protection and soft start
- No additional protection such as current overloads are required
- Can be manually speed controlled by pressing 2 internal motor buttons
- Can be remote speed controlled with either a 2-10V, 4-20mA, or 80-1600Hz input signal
- Can be run as an independent ventilation source or integrated into most building management systems
- On board fault identification LED will flash according to fault type
- Integrated “Fire Mode” function forces motor to continue working under adverse conditions (at full speed)
- Easy to fit 35mm TDF profile flange connections
- Robust, yet lightweight galvanised steel construction
- Operating temperature: -20 °C to +60 °C when air velocity exceeds 5 m/s, otherwise -20 °C to +40 °C

## Construction

Galvanised steel housings with 35mm TDF profile flange connections.

Direct drive centrifugal impellers are made from aluminium.

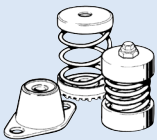
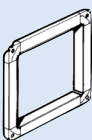
## ANCILLARY EQUIPMENT

 Vibration Isolators Ref. I-1	 POW - Matching Flanges Ref. J-4	 FT - Mounting Foot Ref. J-6
 DCV-POT 0-10V EC Speed Controller Ref. M-20		

## Motors

Type - electronic commutated (EC) motor.

Electricity supply - 220-277V single-phase and 380-480V three-phase, 50/60Hz.

Bearings - sealed-for-life, ball.

IP55 rating.

## Internal Thermal Protection

Integral thermal overload protection is supplied as standard

## Testing

Air flow tests to ISO5801 : 2007

Noise tests to BS848:Part 2, 1985

## Special Note

EC motors should be directly connected to their appropriate AC supply. EC motors should not be regularly power cycled.

\* Future IE6 level of efficiency, considering 20% less losses than IE5 according to IEC TS 60034-30-2 for variable speed electric motors.

## SUGGESTED SPECIFICATION

The duct mounted fans shall be of the in-line centrifugal ECOtronic PowerLine Series as designed and manufactured by Fantech Pty Ltd and be of the model numbers shown on the schedule/drawings.

They shall include galvanised steel housings with 35mm TDF profile flange connections.

They shall be driven by a EC shaft motor with integrated speed controller and motor overload protection. The direct drive centrifugal impellers will be made from aluminium.

All models shall be fully tested as a complete assembled unit to ISO5801: 2007 for air flow and BS848:Part 2, 1985 for noise

## HOW TO ORDER

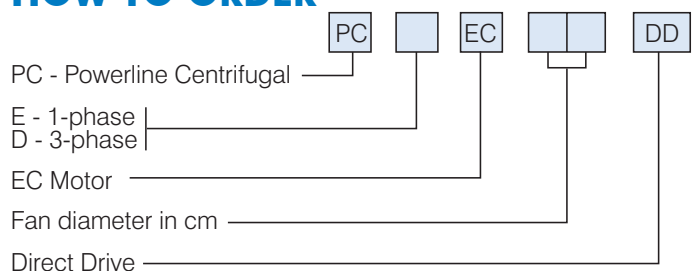

## DIMENSIONS

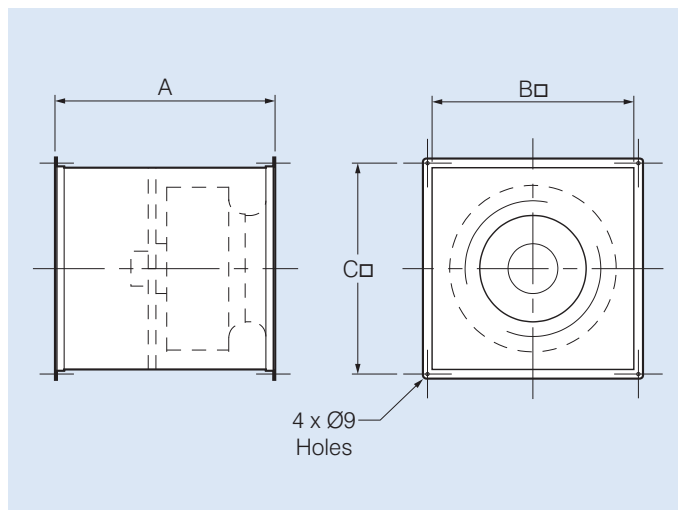

Model	A	B	C	Approx. weight kg.
PCDEC..DD				
PCEEC..DD				
31.	500	400	433	25
35.	550	450	483	30
40.	550	500	533	36
45.	600	550	583	50
50.	700	650	683	58
56.	800	725	758	80

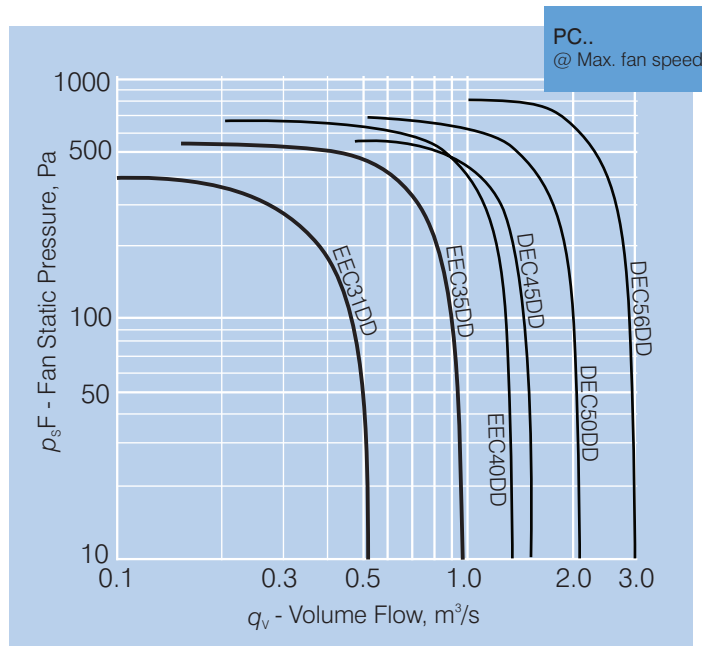

## TECHNICAL DATA & NOISE LEVELS

Model	Max. Fan Speed rev/sec*	Avg. dB(A) @ 3m	PCEEC..DD 1 ph.		PCDEC..DD 3 ph.		In-Duct Sound Power Levels, dB							
			kW	Amps	kW	Amps	63	125	250	500	1k	2k	4k	8k
31.	30	54	0.37	3.2	-	-	89	83	75	72	64	64	62	56
35.	30	58	0.55	4.2	-	-	85	83	79	76	67	69	68	58
40.	30	60	1.10	8.9	-	-	88	86	81	78	71	72	72	65
45.	25	59	-	-	1.50	2.9	86	84	79	76	70	71	71	67
50.	25	63	-	-	1.50	2.9	89	89	84	78	75	75	75	72
56.	25	67	-	-	3.00	5.7	93	94	90	81	80	79	79	77

\* The fan will maintain the set speed whether run on 50 or 60Hz supply.



Scan the QR Code to view more information online.

