

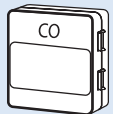





JETVENT CAR PARK EC FANS - LH & ULH SERIES

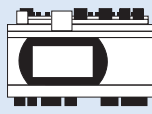
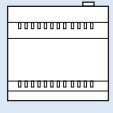

ANCILLARY EQUIPMENT

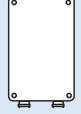
 CO/NO _x Sensor	 Decentralised Smoke Detector	 Aviator MAX/MINI Controller
 Aviator MAX Expansion Module	 Aviator 4.3" & 7" GUI	 VLT - Variable Speed Drive
 Aviator Fan Interface Module	 Comlink Repeater Module	 Supply & Exhaust Fans

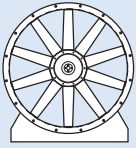
DESCRIPTION

The EC series of Low Profile JetVent fans are designed to clear harmful pollutants from enclosed and semi-enclosed spaces. They feature a compact overall size and a very narrow height, which may enable the car park's floor to ceiling dimensions to be reduced.

The Low Profile series comes in two different sizes and impeller variation. The three phase model with a centrifugal aluminium impeller has been developed for higher air flows and has a pre-set speed thrust rating of 23 Newtons. The Low Profile JetVent also comes as a much more compact, single phase unit with mixed-flow 'Ultra' impeller, has been designed to be quieter and has a pre-set speed thrust rating of 18.9 Newtons.

Features

- The LH JetVent is a three phase EC model and the ULH JetVent is a single phase EC model.
- An energy efficient ventilation system that provides the ventilation rate according to the CO or NO_x pollutant levels in the space.
- Available with a factory fitted and fully integrated smoke detection kit mounted to the side of the JetVent fan.
- Additional decentralised smoke detectors can be connected to the JetVent system based on car park layout.
- Utilises Aviator controls to digitally connect JetVent fans, Supply & Exhaust fans, Sensors and the BMS together.
- Aviator controls with propriety ComLink system provides a simple control wiring scheme with easy installation, fast commissioning and a high level of system monitoring.
- EC motor features reverse polarity protection, locked rotor protection and soft starting.
- EC motor technology eliminates the need for external VSDs, current overloads and motor phase protection.

Construction

Low-profile galvanised steel housing with aerodynamically designed internal flow elements. Light grey powder coated finish as standard. The Low Height model (LH) has a backward-curved centrifugal impeller made from durable aluminium. The Ultra, Low Height model (ULH) has a mixed-flow impeller made from high performance injection moulded composite material.

Internal Thermal Protection

Integral thermal overload protection is supplied as standard.

Wiring Diagram

Refer to the latest JetVent Carpark Ventilation Solutions Application Guide for an overview of wiring schemes. Contact your Fantech sales engineering team for further information.

Motors

Type - Electronically commutated (EC) Motor.

Electricity supply: LH model: 380V-480V, three-phase, 50/60 Hz.

ULH model: 230V, single-phase, 50/60 Hz

Bearings - sealed-for-life ball.

See page 0-7 for details on motors.

Integrated EC-Controller providing infinite speed control.

Integrated EC speed control over analogue 0-10V or 4-20mA, PWM or MODBUS High Level Interface over RS485.

Testing

Thrust-air performance based on tests to BS848 Part 10,1999: "Fans for general purpose - Performance testing of jet fans."

Noise data based on tests to BS848: Part 2:1985.

Special Note

In most cases Jet fans will be treated as a mechanical performance solution within the National Construction Code (NCC) (formally the BCA). Where required, a mechanical performance solution should comply with the AFAC Guideline 1.0 on Fire Safety for impulse (Jet) fans in Car Parks, and be approved by the appropriate authority. The mechanical performance solution should contain a pollutant analysis and detailed justification to demonstrate the jet fan system will not have a significant detrimental effect on the safe egress of occupants or operation of the sprinkler system.

JETVENT CAR PARK EC FANS - LH & ULH SERIES

SUGGESTED SPECIFICATION

The high velocity jet fans shall be of the low height JetVent JIU-CPCEC Series as designed and manufactured by Fantech Pty Ltd and be of the model numbers shown on the schedule/drawings. The impellers must be driven by EC external rotor motors with integrated EC-Controller and integral thermal overload protection. They shall be pre-configured to suit CO/NOx sensors and the required applications.

The housing shall be of galvanised steel with a light grey powder coated finish as standard. They shall incorporate mounting feet and aerodynamically designed internal flow elements.

Performance data shall be based on tests to BS848:Part 10,1999 for thrust and ISO3744 or ISO13347-3 for noise.

HOW TO ORDER

Step 1

Select the digital EC JetVent fan model

JIU-JetVent Induction

CPCEC - CarPark Centrifugal, EC Motor

LH - Low Height

ULH - Ultra Low Height

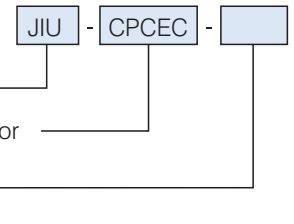

Step 2

Select isolator or smoke detection kit

Smoke Detector Kit



LH
ULH

JIU-SMOKEKIT
JIU-SMOKEKIT-ULH

or

Isolator Kit



LH
ULH

JIU-ISOLATORKIT
JIU-ISOLKIT-ULH

Refer to the latest JetVent Carpark Ventilation Solutions Application Guide for further selection information.

DIMENSIONS

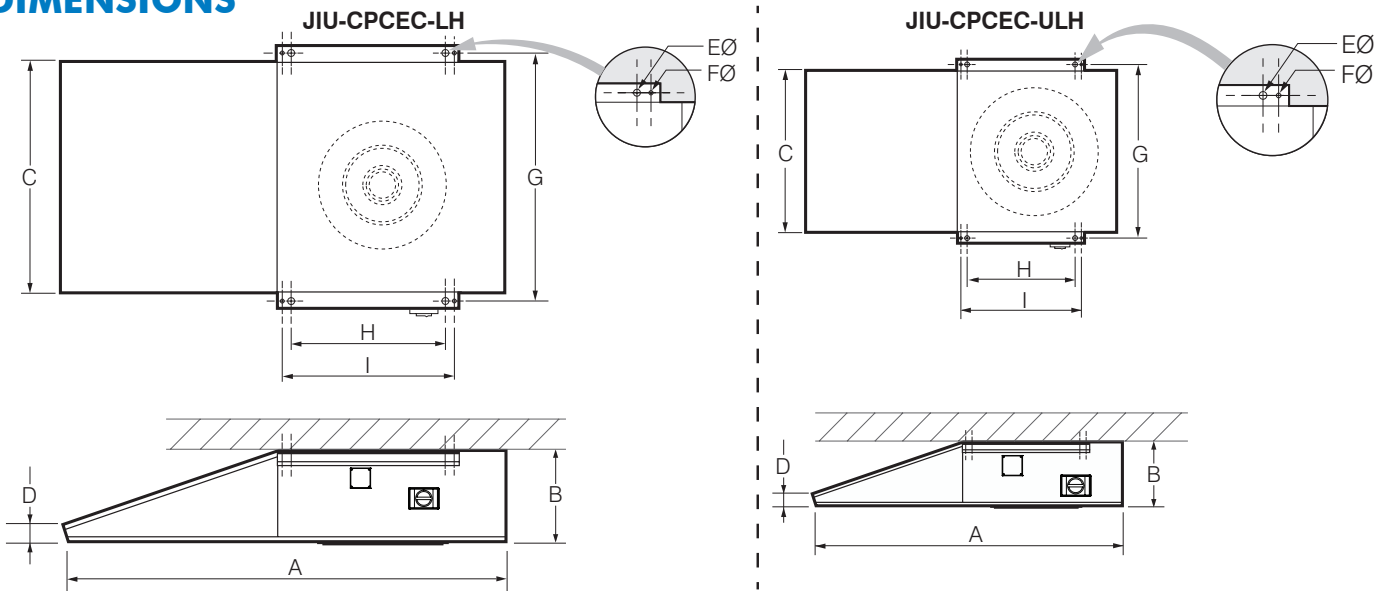

Model JIU-CPCEC-..	Dimensions, mm									Approx. wt. kg
	A	B	C	D	EØ	FØ	G	H	I	
LH	1745	322	906	68	25	13	973	605	675	89
ULH	1040	262	488	55	20	12	537	350	410	26

TECHNICAL AND NOISE DATA

Model JIU-CPCEC-..	Fan Speed rev/sec	Free Air m ³ /s	Thrust N	JIU-CPCEC-..		Max. °C	Car park Installed Noise Levels dB(A)#	Free-field Noise Rating dB(A) @ 3m**	Sound Power Levels L _w dB re 1pW								
				3 ph. kW	Amps				63	125	250	500	1k	2k	4k	8k	
LH	High Speed	30	1.50	46.8	1.7	2.6	40	76	69	82	85	91	83	84	82	80	74
	Pre-set Speed*	19	0.93	18.9	0.4~	0.8	40	65	57	74	82	73	71	71	73	65	56
ULH	High Speed	35	0.66	23	0.56	2.8	60	65	57	73	78	80	73	71	70	65	61
	Pre-set Speed*	35	0.66	23	0.56	2.8	60	65	57	73	78	80	73	71	70	65	61

Car park installed noise levels apply 8m away from the fan with multiple fans operating.

** Free-field noise rating applies 3m away from the fan with single fan operating.

~ Estimated power consumption.

* Pre-set speed so fan does not operate above the AS2107:2016 recommended noise level of 65dB(A) @ 8m.