

# INLINE FILTERED SUPPLY UNIT EC SERIES

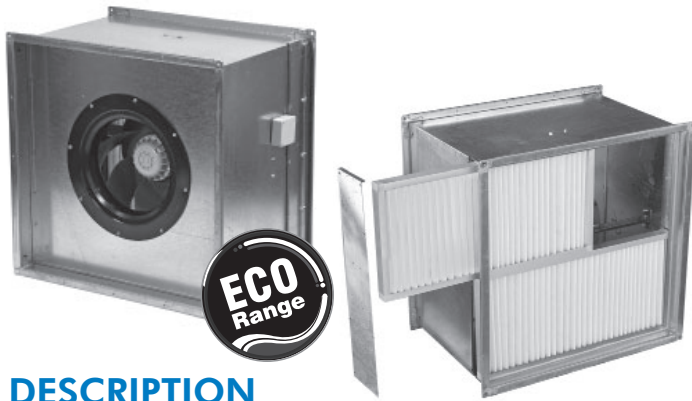

## DESCRIPTION

The EC Series of Inline Filtered Supply Units has been designed to provide filtered outside air to a range of applications where direct fresh air intake is not possible or practical.

They incorporate the latest state-of-the-art EC motor technology. The range features fully integrated, infinitely variable speed control which eliminates the need for external VSDs, current overloads and motor phase protection. They are an energy saving solution and are most efficient where conditions vary during the course of the day.

## Typical Applications

Filtered supply air into areas such as switch rooms, data rooms, commercial kitchens, shopping centres, factories and warehouses.

## Features

- Robust, yet lightweight galvanised steel construction
- Mixed-flow impeller with high performance blade geometry
- Pure-V washable G4 filters on the fan discharge side that can be easily accessed via a removable side panel
- EC motor features reverse polarity protection, locked rotor protection and soft starting
- No additional electrical protection such as contactors are required
- All models supplied standard with 0-10V control input
- Supplied with TDF flanges as standard for inline mounting or installed with an external grille for flush to wall mounting

## Construction

Galvanised steel housing with material filters on the discharge side of the fan. Industry standard 35mm TDF profile flange for easy connection to ducting.

## Motors

Type - electronic commutated (EC) motor.

Electricity supply - 200-277V single-phase, 50/60Hz or 380-480V three-phase, 50/60Hz

Integrated EC-Controller providing infinite speed control

Bearings - sealed-for-life, ball.

See page O-7 for details on motors.



## Internal Thermal Protection

Integral thermal overload protection is supplied as standard.

## Wiring Diagram

Scan the QR code on the next page to view wiring diagrams online.

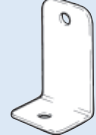
## ANCILLARY EQUIPMENT

 <p>Vibration Isolators Ref. Section I</p>	 <p>FT - Mounting Foot Ref. Section J</p>	 <p>Controllers &amp; Sensors Ref. Section M</p>
 <p>RV - Alfa Relief Vent Ref. Section D</p>		

## Testing

Air flow tests based on ISO 5801.

Noise tests based on ISO 13347-3.

Performances shown are based on clean filters.

As air flow will be affected by room pressurisation, care should be taken to ensure adequate air relief is provided.

## Special Notes

### Pure-V filters

The Inline Filtered Supply Unit incorporates Pure-V filters that are pleated for extra durability and will hold their shape without the need of a wire support metal cage.

Pure-V panel filters are washable.

The filters should be checked during cleaning for wear or damage and replaced when necessary. They can be removed via the side access panel on the discharge side of the fan.

Pure-V filters are tested with an efficiency of G4 to standard EN 779:2002.

### Differential Pressure Switch

A differential pressure switch can be used to provide indication that the filter needs maintenance.

## SUGGESTED SPECIFICATION

The Inline series of Filtered Supply Units shall be designed and manufactured by Fantech Pty Ltd and be of the model numbers shown on the schedule/ drawings.

The unit will have a galvanised steel housing with 35mm TDF profile flange connections.

It will include Pure-V washable G4 filters on the discharge side of the fan.

The unit shall incorporate a Mixed-Flow impeller made from high performance injected moulded composite plastic. They shall be driven by EC external rotor motors with integrated EC controller and integral thermal overload protection.

All performance data shall be for a complete assembled unit, and based on ISO 5801 for air flow and ISO 13347-3 for noise.

## HOW TO ORDER

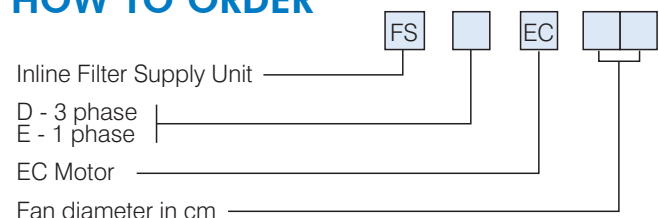

# INLINE FILTERED SUPPLY UNIT EC SERIES

## DIMENSIONS

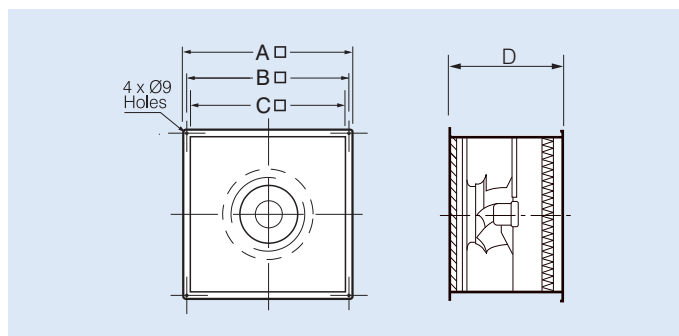

Model	Dimensions, mm				Approx. Weight kg.*
	A	B	C	D	
FSDEC..					
FSEEC..					
31..	720	683	650	570	35
35..	820	783	750	630	43
40..	820	783	750	630	45
45..	970	933	900	700	63
50..	970	933	900	700	69
56..	1120	1083	1050	750	84

\* Unit weights depend on the make of motor used. If critical this should be referred to our sales department at time of order.

## PERFORMANCE CURVE

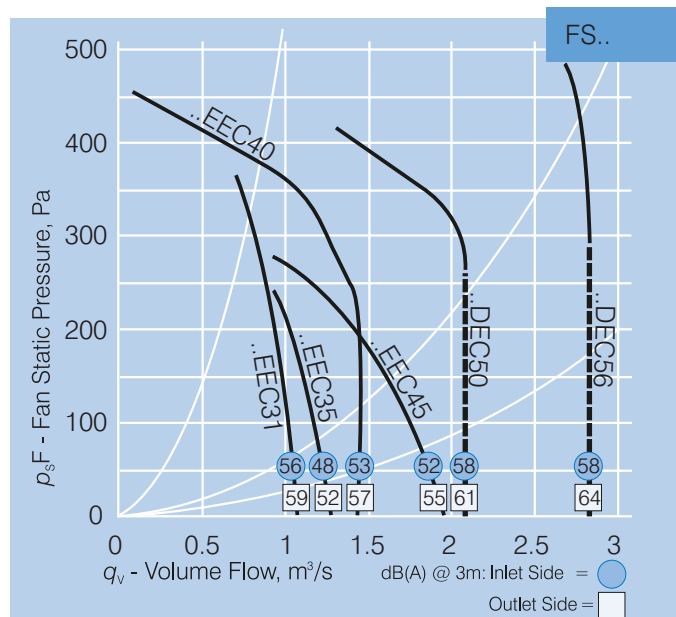

\*\* Filter Air Velocity Limit - Where the performance curve drops vertically (indicated with a dashed line) the fan must be speed controlled.

\*\*\* Performance curves include a 30Pa pressure loss allowance for clean filters.

## TECHNICAL DATA

Model	*Max. Fan Speed, rev/sec	Max Operating Temp (°C)		Avg. dB(A) @ 3m	FSEEC.. 1 ph.		FSDEC.. 3 ph.	
					kW	Amps	kW	Amps
FSEEC31	35	55	Inlet	56	0.55	2.42	-	-
			Outlet	59				
FSEEC35	28	55	Inlet	48	0.50	2.19	-	-
			Outlet	52				
FSEEC40	26	55	Inlet	53	0.84	3.68	-	-
			Outlet	57				
FSEEC45	20	60	Inlet	52	0.65	2.84	-	-
			Outlet	55				
FSDEC50	23	40	Inlet	58	-	-	1.40	2.21
			Outlet	61				
FSDEC56	24	60	Inlet	58	-	-	2.65	4.05
			Outlet	64				

\* The fan will maintain the set speed whether run on 50 or 60Hz supply. Please use Fans by Fantech Selection Program for sound power levels



Scan the QR Code to view more information online.

