



DESCRIPTION

The VentMajor Series of duct-mounted centrifugal in-line fans is designed to exhaust or supply air to a wide range of applications.

There are 6 models in the series, ranging from 100 to 315mm diameter spigot sizes.

Typical Applications

Suitable for ventilating in residential, commercial and industrial applications such as wine cellars, toilets, kitchens and bathrooms in homes, hotels, apartments and offices. Also suitable for equipment cooling.

Features

- High performance impellers of backward-curved design ensuring a stall free performance.
- External rotor motors.
- Designed for direct connection to standard diameter circular ducting.
- Suitable for both supply and exhaust air applications.
- Electrical junction box fitted.
- Mounting foot supplied as standard.
- All models can be mounted at any angle.

Construction

The housings are made of pressed galvanised steel providing a very robust construction. Impellers are backward-curved centrifugal, driven by external rotor motors.

Motors

Type - external rotor motors.

Electrical supply - 230V, single-phase, 50/60Hz.

Bearings - sealed for life, ball.

Speed-controllable.

Class B insulation, IP44.

See pages O-2/3 for details on these motors.

Testing

Air flow to ISO5801: 1997 and AMCA 210-99.

Noise to BS848: Part 2, 1985.

Internal Thermal Protection



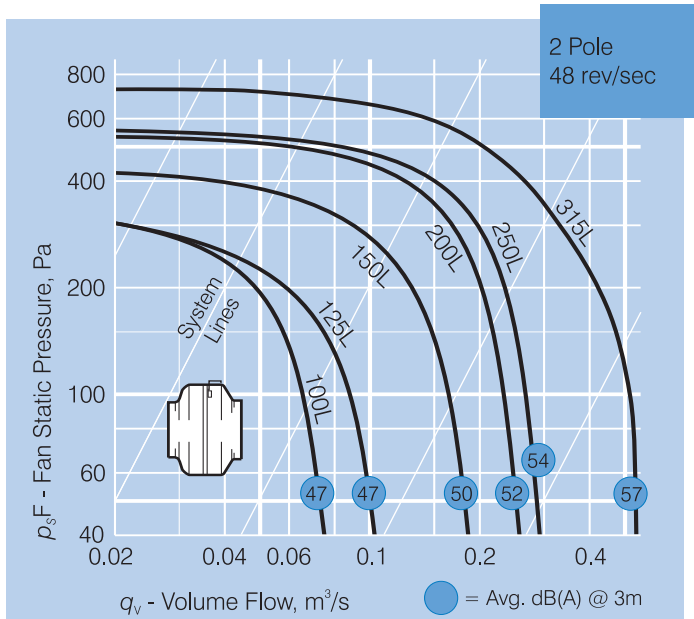

Manual-reset type

Wiring Diagram

See page N-8, see diagram ER6

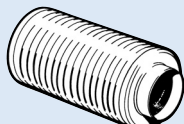

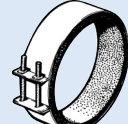
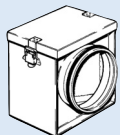
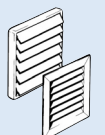
ANCILLARY EQUIPMENT

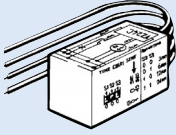
 CC - Circular attenuator Ref. H-16	 Backdraft dampers Ref. J-3	 FC - Fast clamp Ref. J-5
 FGR - Filter Unit Ref. J-10	 Ducting, Louvres & Grilles Ref. L-6/14	 VA - Speed controller Ref. M-5
 VZ - Run-on Timer Ref. M-14		

SUGGESTED SPECIFICATION

In-line fans of the VentMajor Series shall be as supplied by Fantech Pty. Ltd.

Impellers shall be backward-curved centrifugal design and driven by speed-controllable external rotor motors with integral thermal overload protection.

The housing is of pressed galvanised steel.

All models shall be fully tested to ISO5801: Part 1, 1997 or AMCA 210-99 for air flow.

HOW TO ORDER

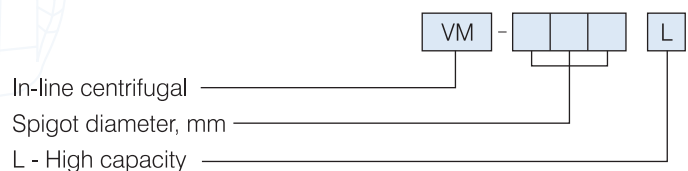

TECHNICAL DATA

Model Number VM-...	Fan Speed rev/sec	Avg dB(A) @ 3m	VM.. 1 ph.		Max. °C
			Watts	Amps	
100L	42	47	75	0.33	60
125L	41	47	80	0.35	60
150L	45	50	120	0.53	60
200L	43	52	170	0.72	60
250L	46	54	180	0.80	60
315L	45	57	315	1.30	50

NOISE DATA

Model Number VM-...	In-duct Sound Power Levels L _w dB re 1pW							
	63	125	250	500	1k	2k	4k	8k
100L	67	63	70	61	64	58	50	42
125L	63	60	69	65	62	59	52	43
150L	64	66	70	70	65	61	55	43
200L	66	67	70	71	67	64	62	55
250L	67	70	73	72	70	67	65	56
315L	68	71	75	71	71	69	64	61

Sound Power Levels shown are for the Inlet Side of the unit.

DIMENSIONS

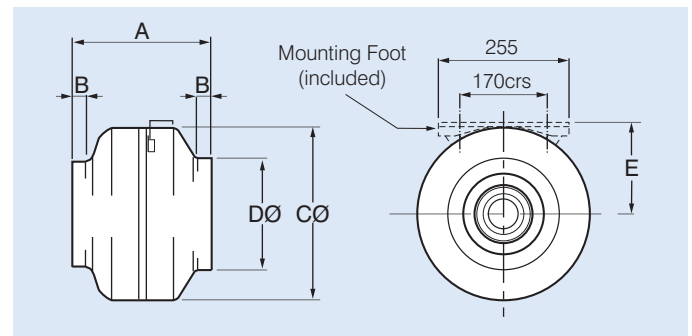

Model Number VM-..	Dimensions, mm					Weight kg.
	A	B	CØ	DØ	E	
100L	194	23	243	98	129	3
125L	195	27	243	123	129	3
150L	214	24	333	147	174	5
200L	223	25	333	198	174	5
250L	206	27	333	248	174	6
315L	230	25	401	312	208	8



Scan the QR Code to view more information online.

