

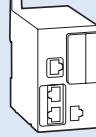

AIRLINK DX CONTROLLER

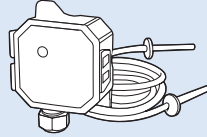
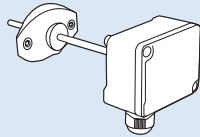

ANCILLARY EQUIPMENT

 AirLink Communications Module, Ref. K-20	 AirLink Duct Pressure Sensor, Ref. K-21	 AirLink Supply Air Duct Probe, Ref. K-22
 AirLink Wall Plate Switch, Ref. K-23	 AirLink Wall Temperature Sensor, Ref. K-24	

DESCRIPTION

The AirLink DX Controller helps create a complete HVAC management system for commercial buildings where Fan Coil Units (FCU) or Air Handling Units (AHU) are used. It can manage one unit and operate single or variable speed fans.

The DX model AirLink controller is used with Air or Water Cooled Systems that are either ducted packaged AC units or split system AC units.

Features

- Connects to a Fan Coil Unit (FCU) or Air Handling Unit (AHU) with one thermal zone
- Used with either Constant Diffusers or Rickard Variable Air Volume (VAV) Diffusers
- On/Auto/Off mode of operation with afterhours run-on timer with real time clock
- Can be set to analogue or Modbus operational mode
- Hot / Cold valve variable control or On/Off
- Variable Fan speed control or On/Off
- IP20 Protection Class

Standard I/O

- 2 x Digital Inputs
- 8 x Analogue Inputs
- 6 x Digital Outputs
- 8 x Analogue Outputs

Ports

- 1 x USB type A - USB type A female
- 1 x USB type mini B - USB device port Mini-B
- 2 x RS485 - screw terminal block (Modbus serial link)
- 1 x Ethernet - RJ45 (Modbus TCP and BACnet IP with webserver)

Wiring Diagram

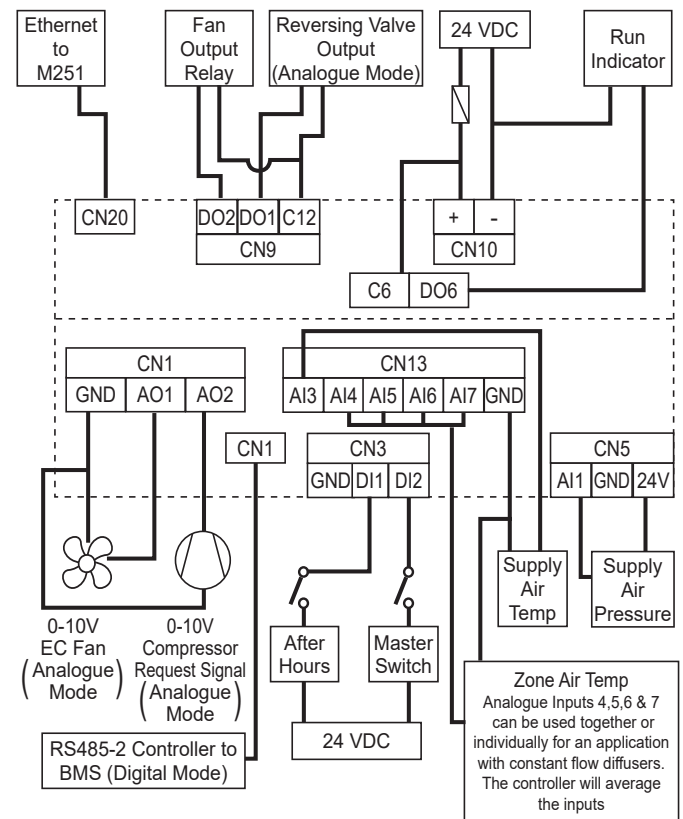

DIMENSIONS

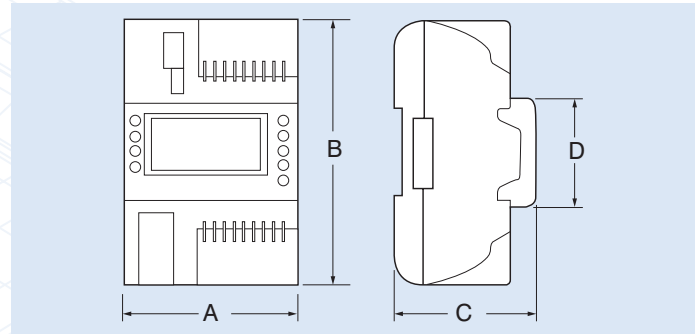

Model Number	Dimensions, mm				Kit includes
	A	B	C	D	
DCV-ARLK-DXKIT	72	110	60	45	DX Controller, Connectors, Air Duct Probe, Transformer & Fuse